

OPTIMA

CLOSED CIRCUIT REBREATHER

USER MANUAL



DIVE RITE®



This is the user manual for the Dive Rite O2ptima eCCR rebreather.

This user manual is proprietary and copyright Lamartek, Inc. 2020. It may not be reproduced, changed, or distributed without authorization from Lamartek, Inc.

All information contained in this manual has been carefully reviewed and is believed to be accurate, however it is subject to change. Rebreather technology is constantly and rapidly evolving. Please check www.diverite.com to ensure that you have the latest version of this manual.

Companies and/or product names cited in the manual are trademarks belonging to their respective companies.

The O2ptima is manufactured in the USA by:

Lamartek, inc. dba Dive Rite

175 NW Washington Street

Lake City, FL, 32055 USA

Phone (386) 752-1087

www.diverite.com



General Safety Statements and Warnings



- **DO NOT** use the O2ptima without successfully completing an O2ptima specific training program.
- **DO NOT** use the O2ptima without reading and understanding this manual in its entirety.
- Reading this user manual **DOES NOT** replace unit specific training. This manual does not provide directions for diving with closed circuit rebreather equipment. This manual is only intended to be a guide for the proper maintenance, setup, operation, and basic service of the O2ptima rebreather.
- As with any piece of equipment, this rebreather will eventually fail. Even careful maintenance, assembly, and testing will not prevent this from happening. It is possible that any part of this unit **may fail at any time**. Because of this, it is essential that a separate, independent bailout system be taken by the diver on every dive. The bailout system must be configured to allow safe termination of the dive and return to the surface in the event of a malfunction at any point during the dive.
- All components of the rebreather must be in good working order and be carefully maintained, assembled, and tested to reduce the risk of failure.
- Participation in rebreather diving can result in **serious injury or death**. These risks can be reduced, but never eliminated.
- Knowledge and training are the best tools for avoiding accidents.
- Rebreather diving is a physically as well as mentally demanding activity.
- If you do not have adequate training, equipment, physical conditioning, and proper mind-set, do not get in the water.
- As the diver, **YOU have the final responsibility** for your own actions and safety while using this rebreather.



Table of Contents

General Safety Statements and Warnings	3
Introduction	7
Design Philosophy	7
System Overview	8
The Breathing Loop	9
Component Features & Functions	10
Counter Lungs	10
Breathing Hoses & Fittings.....	10
Divesoft BOV + ADV + MAVs	10
Overpressure/Dump Valve	11
Scrubber Canister.....	12
Scrubber End Cap & Water Trap.....	12
Electronics Head	12
Oxygen Sensors	13
Controller	14
Electronics/Battery Canisters.....	14
HUD.....	15
Regulators, Hoses, & Gauges	15
Cylinders & Valves.....	16
Stand	16
Cover	17
Harness	17
Air Cell	17
Micropore ExtendAir Cartridge Overview	19
Assembling the O2ptima	21
Importance of Checklists.....	21
Gas Analyzation.....	21
Installing the Cylinders and Regulators	21
How to Install a Micropore ExtendAir Cartridge.....	22
January 2020 © Lamartek, Inc. dba Dive Rite	4



How to Pack the Scrubber 23

Installing the Scrubber Assembly..... 26

Installing the Electronics Head..... 27

Installing the Scrubber End Cap & Water Trap..... 28

Mounting the Electronics/Battery Canisters 30

Installing the Air Cell & Harness..... 31

Installing the Cover 33

Installing the Loop Hoses 33

Basic Operation & Use 35

 Harness Adjustment..... 35

 Adding Trim Weights 35

 Oxygen Sensor Calibration..... 35

 BOV Operation..... 36

 Breathing on the Loop 37

 Electronic vs Manual Operation 37

 Diluent Injection..... 38

Servicing, Maintenance, & Cleaning 38

 Post Dive Procedures & Cleaning..... 38

 Oxygen Sensor Care 39

 Oxygen Sensor Replacement 41

 Battery Replacement 43

 Battery Recommendations 44

 Storage 44

 Annual Service 45

 Recommended Care Products 45

Technical Specifications 45

Revisions & Changes in Documentation..... 47

Appendix I: Checklists 47

 Assembly Guide Checklist 48

 Survival Checklist 49



Pre-flight Checklist.....	49
Post Dive Checklist.....	50
Appendix II: Galvanic Oxygen Sensors Applied to Closed Circuit Rebreathers	
by Analytical Industries, Inc.	51



Introduction

Congratulations on your purchase of the O2ptima rebreather! First produced in late 2005, the O2ptima has been a leader in the rebreather market for over a decade. During that time it has been used for cutting edge exploration and world class expeditions all over the planet. Dive Rite has made a strong commitment to ensuring that it is one of the most reliable, capable, and high performing rebreathers on the market. The O2ptima design continues to evolve as refinements are made and new technology becomes available. We are certain that this unit will provide you with many unforgettable hours exploring your underwater world.

Design Philosophy

The design parameters for the O2ptima were simple:

- Keep the breathing loop as short as possible
- Use proven, state of the art electronics
- Be fully compatible with the Micropore ExtendAir cartridge
- Maintain a rugged and durable package in the smallest profile possible

These parameters were originally chosen in order to produce a rebreather ideally suited to underwater cave exploration. The unique challenges of the cave environment demanded a unit that was as safe and reliable as possible while maintaining a minimal profile. The end result was a rebreather that is not only highly suitable for cave diving, but also any other type of technical diving where a direct ascent to the surface is not always possible.

By utilizing a horizontally mounted scrubber canister behind the divers head, the breathing loop was kept as short as possible. This helps to create the lowest possible work of breathing and allows the use of smaller diameter loop hoses. This in turn increases comfort and reduces diver fatigue. Mounting the scrubber canister at the highest point of the loop has the additional advantage of reducing the likelihood of water entering the scrubber. This, combined with the use of the Micropore ExtendAir cartridge, greatly reduces the possibility of a “caustic cocktail.”

The O2ptima now utilizes Shearwater electronics for their proven and unparalleled reliability and functionality.

At Dive Rite, we understand that one size does not fit all, so in addition to the standard O2ptima features there are a number of options to ensure a proper fit for any diver and mission. Contact Dive Rite or visit www.diverite.com for more details.



System Overview

The O2ptima is an electronically controlled, constant PPO₂, fully closed circuit rebreather (eCCR). It has built-in decompression calculation and mixed gas capabilities. The following features come standard on the unit:

- Back mounted counterlungs with 6.5 Liter loop volume
- Redundant Shearwater DiveCAN electronics including heads-up display (HUD) and Petrel 2 controller
- Dual use scrubber canister design that can be used with Micropore ExtendAir cartridges or packed with loose CO₂ absorbent
- Divesoft BOV + ADV + MAVs standard (all-in-one Bail Out Valve with Automatic Diluent Valve and Manual Add Valves for O₂ and diluent) DSV optional
- Dual water traps
- Regulators and hoses
- (4) AI R22 Oxygen Sensors
- CCR XT air cell utilizing abrasion resistant SuperFabric
- Kydex cover for abrasion protection
- Stainless Steel and StarBoard frame and stand
- AL 20 oxygen and diluent cylinders with valves
- Dive Rite TransPac Harness (Transplate harness optional)



The Breathing Loop

The O2ptima incorporates a back mounted, dual counterlung design. The breathing loop consists of the BOV or DSV, breathing hoses and hose fittings, inhalation and exhalation counterlungs, scrubber canister, canister end cap, and electronics head. Gas flows in a clockwise direction—from the left shoulder—to the diver—to the right shoulder.

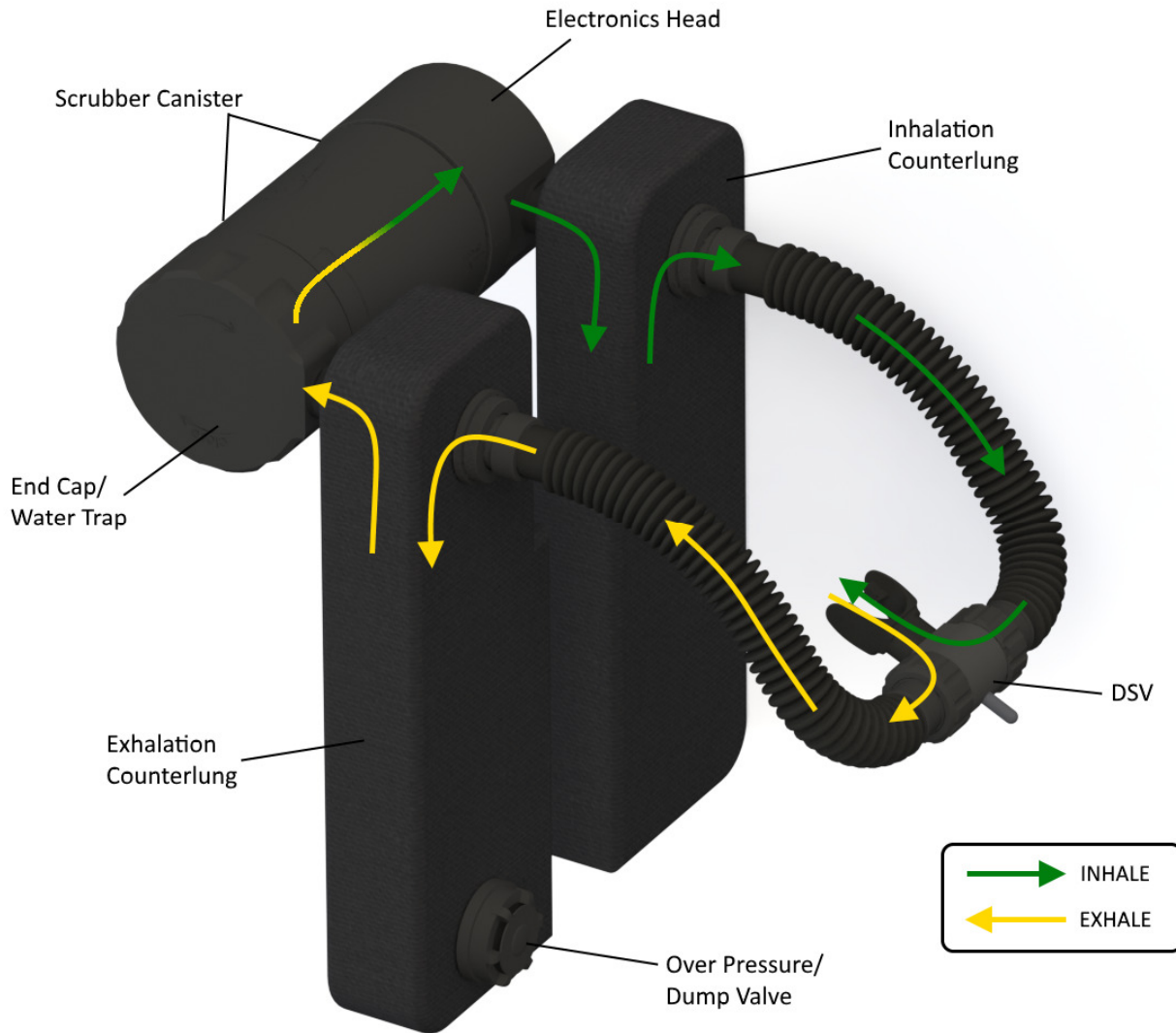



Component Features and Functions

Counterlungs

The O2ptima uses two detachable back mounted counterlungs. The counterlung position keeps them as close to the diver's lung centroid as possible providing excellent breathing characteristics in a variety of diver positions. They are adjustable for optimal positioning and easily unzip from the center panel to remove for cleaning and inspection.



The counterlungs consist of an abrasion resistant outer bag and a removable welded polyurethane inner bladder. The bladder is accessible through a zipper on the side of each counterlung.

The back side of the counterlungs attach directly to the scrubber canister. The breathing loop hoses attach to the front of the counterlungs using threaded connections.

The exhalation counterlung has an overpressure/dump valve located at the bottom of the lung. An internal water trap is located in the bottom of the exhalation counterlung to make de-watering the loop easy.

Breathing Hoses & Fittings

The hose diameter and lengths have been specifically chosen to provide the best balance of comfort and low work of breathing. The hose lengths are some of the shortest in the industry due to the location of the behind-the-head scrubber canister. This not only keeps the work of breathing low, but also reduces drag and uncomfortable vibrations occasionally encountered with excessive hose lengths when scootering or swimming against strong flow.



The hoses have threaded fittings attached to the counterlung ends. Each fitting utilizes a double O-ring seal to help ensure loop integrity. The hoses are 15 inches in length standard. Other sizes are available for improved fit on smaller divers.

Divesoft BOV + ADV + MAVs

The Divesoft BOV (Bail Out Valve) comes standard on the O2ptima. (The Dive Rite DSV is optional.) The BOV features an integrated ADV (Automatic Diluent Valve) and manual oxygen and diluent addition valves.

The BOV and ADV functions are controlled by the knob on the front of the BOV. With the knob turned horizontally, the BOV is in closed-circuit mode and you are breathing "on the loop". Bailing out is





accomplished by turning the knob 90 degrees so that is vertical. This closes the loop and activates open-circuit mode using the integrated 2nd stage. The BOV is plumbed to the onboard diluent tank. Because of the small size of the tank, the BOV does not eliminate the need for a separate, independent bailout system.

The integrated ADV can be activated or deactivated by pressing the button on the knob and rotating the knob 180 degrees. The ADV only functions in closed circuit mode and does not affect open circuit operation, i.e. when the knob is vertical the open circuit function is the same even if it is turned 180 degrees.

The ADV uses a built in demand valve that is activated by negative loop pressure against a diaphragm in the same manner as a standard second stage regulator. The ADV design feeds diluent gas directly to the BOV. This provides a fast, hands-free method of receiving a known breathable gas as well as supplying additional gas to increase loop volume.

The BOV should be turned to open circuit mode (vertically) when on the surface or during a bailout procedure to prevent water from entering the loop.

The integrated Manual Addition Valves (MAVs) are located on the front of the BOV. The green button on the right side of the diver's mouth is the oxygen addition button, and the black button on the diver's left is the diluent addition button. Low pressure supply hoses are attached to the threaded fittings located next to each button.

Manual diluent addition is injected just upstream of the BOV to provide an immediate known breathable gas mix. Manual oxygen addition is injected downstream of the BOV so that it must travel through the loop before being inhaled. This prevents oxygen spikes to the diver and ensures that the gas mixture is homogenous before traveling over the oxygen sensors and being inhaled.

The BOV uses a snap ring system to attach the hose fittings to the BOV body. To remove the fittings for cleaning or inspection of the mushroom valves, simply remove the wire snap ring from its locking groove and gently pull the fitting away from the body.

If the BOV is unused for a period of time, the knob may become difficult to turn. This is normal and is due to the lubricant taking a set. Turning the knob back and forth several times before the dive will redistribute the lubricant and ensure that the knob is smooth and easy to turn.

Overpressure/Dump Valve

The O2ptima uses a special loop overpressure valve (OPV) located on the front side of the exhalation (right) counterlung. A specific spring is used to optimize the cracking pressure for rebreather counterlung use. Do not replace with a standard drysuit exhaust valve as they can have a much higher cracking pressure which can lead to lung overexpansion injuries.



This valve will normally be operated in the open position (turned fully counter-clockwise). Divers with a large tidal volume may find that they need to close the OPV slightly in order to maintain proper loop volume. The valve can also be manually opened by pressing on the valve. The valve is screwed into a welded flange on the counterlung inner bladder.



During an ascent, the gas in the loop will expand, increasing buoyancy and slightly increasing the breathing effort. Even though the maximum volume in the O2ptima's breathing loop is relatively small, it is important to set the OPV properly so that buoyancy shifts will be kept to a minimum without any diver action.

Scrubber Canister

The scrubber canister contains the scrubbing media that removes CO₂ from the breathing loop. The O2ptima uses an axial style scrubber canister and can be used with either Micropore ExtendAir cartridges or loose packable CO₂ absorbent.

Assembly is slightly different depending on which scrubber media is used. The wave spring and top plate with screen are not used when using an Extendair cartridge. The finger nut is reversible. It is used in one direction when packing loose CO₂ absorbent and is flipped over when using Extendair cartridges. See the **How to Pack the Scrubber** section for more information on properly setting up the scrubber canister.



Scrubber End Cap & Water Trap

The scrubber end cap contains a snap-in water trap in the shape of a cone. This shape prevents excess water from entering the scrubber canister regardless of the diver's position in the water.

The shape of the cone also assists in mixing the exhaled gas with added oxygen into a homogenous blend. The result is even gas flow through the scrubber canister and accurate readings by the oxygen sensors.

The end cap has an O-ring and a flat seal that seals against the scrubber canister and an additional O-ring that seals the water trap. These O-rings and seal require cleaning and maintenance and should be replaced on an annual schedule at a minimum.

The end cap attaches to the scrubber body by aligning the marks on the cap and body, pressing the cap into place, and the turning the cap clockwise until the mark is aligned with the "locked" position marking.



Electronics Head

The electronics head contains the solenoid, oxygen sensors (4), sensor disk, sensor wiring harness, and oxygen injection premix tube. These components are responsible for analyzing the oxygen content of the breathing gas and injecting oxygen as needed.

The controller (Shearwater DiveCan system) interprets the readings from the oxygen sensors and makes decisions on when to add oxygen via the solenoid.





The injected oxygen travels through the premix tube to the exhalation side of the scrubber canister where it is blended with the loop gas before going through the scrubber material. This reduces O2 “spikes” by ensuring that the gas mixture is homogenous before passing over the oxygen sensors.

Oxygen Sensors

The O2ptima uses four oxygen sensors. These sensors are threaded into the sensor disk mounted inside the electronics head. Dive Rite uses Analytical Industries, Inc. type R22D sensors.

Oxygen sensors have a finite life. They are a consumable item and must be replaced at regular intervals. They are typically replaced during the annual service, but may need to be replaced prior to this.

The sensor labeling includes a “Sell by” date of 4 months after manufacture and a “Do not use after” date of 16 months after manufacture. Sensors must not be used after this date even if they appear to still be functioning correctly.



Four sensors are used to provide redundancy and the ability to cross check their values against each other to determine if a sensor is not reading correctly. Sensors 1 and 2 are shared between the controller and the HUD. Sensor 3C is only connected to the controller, and sensor 3H is only connected to the HUD. By comparing sensor readings between the HUD and the controller it is easy to determine if a sensor is not reading correctly.

If sensor values 1, 2, and 3C do not agree, the controller automatically uses a voting logic to make an educated guess of which sensor is not reading correctly. Having an independent “4th sensor” display on the HUD allows the diver to independently verify the controller’s voting logic.

Beginning in Q1 of 2018 Dive Rite will begin shipping all new rebreather units with digital O2 cells. These new sensors from Analytical Industries operate as traditional analog sensors but provide several benefits including:

- Automatic warning for use of sensors past expiry date
- Advanced notification for sensor ordering/replacement
- Monitors for early sensor failure by recording and observing calibration results

All Dive Rite rebreathers produced after September 2017 are compatible with the new digital sensors.

For more information on oxygen sensors, see the **Oxygen Sensor Care** section and also **Appendix II: Galvanic Oxygen Sensors Applied to Closed Circuit Rebreathers** by Analytical Industries, Inc.



Controller

Dive Rite has chosen to use Shearwater electronics to control and monitor the O2ptima. The controller is a DiveCAN Petrel 2 handset. The controller allows diver control of the PPO2 setpoint and PPO2 monitoring of oxygen sensors 1, 2, and 3C. It also functions as a full featured dive computer displaying depth, dive time, decompression information, and other important dive information.

It is recommended to use a second standalone dive computer with decompression information as a backup in addition to the controller.

For detailed information on the DiveCAN Petrel controller, please see the **Shearwater Petrel DiveCAN Rebreather Controller Model Operations Manual**.



Electronics/Battery Canisters

There are two external electronics & battery canisters on the O2ptima. They are mounted behind the air cell in elastic sleeves on each side of the tanks.

The canister on the (diver's) left side of the unit contains the SOLO (SOlenoid and Oxygen) electronics board and battery. The battery is a standard 9 volt battery that powers the SOLO board as well as the oxygen solenoid. The Petrel 2 controller handset has its own internal battery and does not rely on the 9 volt.

The canister on the (diver's) right side of the unit contains the OBOE (Oxygen BOard Electronics) board and battery. The OBOE board controls the HUD. The battery is a standard AA type. This battery only powers the OBOE board and HUD.

By locating the batteries in these external compartments, they are completely isolated from the head and the breathing loop. This is important because as batteries age or are damaged they can release toxic chemicals. Obviously this is not something you want to have in your breathing gas.

The batteries are accessed via a threaded cap on the end of each canister. The caps are double O-ring sealed to ensure water integrity. These O-rings must be inspected and maintained when the canisters are opened to reduce the chance of flooding. See the **Battery Replacement** section for additional information.

The electronics canisters connect to the controller and HUD using wet pluggable, waterproof connectors. Regular lubrication of the inside of these connectors with a light coating of silicone grease such as Molykote 111 will increase their usable life.





HUD

The O2ptima includes a Shearwater HUD (Heads-Up Display). The HUD displays the PPO2 readings of oxygen sensors 1, 2, and 3H. These values are displayed using three columns of LEDs. Each column represents a different sensor. The colored LEDs flash using a modified Smither's code to convey the PPO2 values. A "color blind" mode is also available. The HUD can be setup for right or left eye operation. The HUD can be turned on manually by pressing the button on the end of the housing. There are also wet contacts which automatically turn the unit on in case it was not turned on prior to the dive.



Your life depends on always knowing the PPO2 in the breathing loop while diving a rebreather. Do not make assumptions about how the HUD displays PPO2 values. Previous versions of the HUD used different blink patterns. Refer to the latest **Shearwater HUD User Manual** for a detailed description of the HUD blink pattern and operation.

The Shearwater NERD (Near Eye Remote Display) is also available as an option. (<https://www.shearwater.com/products/nerd/>) The NERD replaces the standard HUD providing a numerical readout of the 3 sensor PPO2 values and also serving as a backup computer with fully redundant decompression and dive information.

Regulators, Hoses, & Gauges

Dive Rite first stages with DIN connectors are used for both diluent and oxygen supply. First stage intermediate pressure (IP) is set to 85 psi for the oxygen regulator and 140 psi for the diluent regulator. The oxygen regulator IP must be set no higher than 85psi due to the maximum rated pressure of the solenoid.



Each regulator is connected to a manifold which supplies gas to the rest of the rebreather. Over-pressurization valves (OPVs) are installed in the manifolds for safety. Because there are no second stages installed there is no way for excess pressure to be released. The over-pressurization valve must be in place in the event of a first stage high pressure seat failure to prevent high pressure gas from reaching all of the downstream components.

An OPV that is releasing pressure indicates a malfunction and the dive should be terminated immediately. The OPV should be inspected for bubbling during the S-drill at the beginning of the dive.

The first stages need to be serviced annually by an Authorized Dive Rite service center or directly by Dive Rite. Call Dive Rite directly (1-800-495-1046) or email support@diverite.com to schedule service.

Braided nylon Airflex LP hoses are used for gas supply throughout the O2ptima. Green hoses designate oxygen, and black hoses designate diluent. Airflex hoses are flexible, yet tough. The hose lengths are optimized for streamlined routing.

High quality brass and glass SPGs are included to monitor oxygen and diluent tank pressures. BAR gauges are used to help simplify gas consumption calculations.



Cylinders & Valves

The O2ptima is supplied with two aluminum 20 cf (3L) cylinders—one for oxygen and one for diluent. Left and Right hand valves are included. One of the valve handwheels is green to designate oxygen use.

The cylinders are held in place with cam straps and Velcro straps. No additional cylinder mounting hardware is necessary.

The AL20 cylinders are a good compromise between weight and gas volume. They are an excellent choice for general rebreather diving. Other recommended cylinders that will work well with the O2ptima are:

- Aluminum 13 cf (2L)
- Steel AA LP13 cf (2L)
- Steel AA LP15 cf (2L)
- Steel AA LP27 cf (4L)
- Steel AA HP32 cf (4L)



Divers should select cylinders based on their dive duration, travel logistics, and buoyancy characteristics.

Stand

The O2ptima uses a hybrid stand consisting of a light weight, laser cut stainless steel backplate attached to a machined StarBoard plastic brace and foot.

The backplate is contoured to sit close to your back like a set of doubles. Slots in the plate accommodate cam straps to attach the cylinders.

StarBoard is a high impact, marine grade polymer. It is very durable and will flex under a load without breaking. StarBoard also has excellent buoyancy characteristics. It is very close to neutrally buoyant in fresh water. The foot is very boat friendly and has integrated mounting rails for accessories. Hand cut-outs on the bottom of the foot make it easy to carry and maneuver the unit on land.



The scrubber canister mounts to the top of the backplate using a special rubberized cam strap to grip the canister and prevent shifting. A StarBoard brace underneath the canister provides additional stability.



Cover

A Kydex cover protects the back of the unit from hazardous overhead environments. It provides hard shell protection for the scrubber canister, hoses, and cylinders. It also keeps the hoses and cords tucked in, reducing drag and potential snag points.

The cover attaches with six plastic buckles—two on the top and two on each side.

Slots at the top and sides of the cover are ideal for adding pockets to hold additional ballast weight, if necessary.

Holes on the sides of the cover allow optional mounting of Dive Rite's QRM receivers for quick and secure attachment of accessories such as a battery canister or small drysuit inflation bottle.

Custom covers are also available. Contact Dive Rite directly for more information.



Harness

The O2ptima comes standard with either a TransPac XT or TransPlate XT harness, but can be used with any standard technical style backplate with 11 inch bolt-hole centers.

Modeled after a mountaineer's backpack style harness, the TransPac incorporates a soft backplate and wrap around hip pads and waist belt to evenly distribute weight across the hips and back. Ergonomic shoulder pads and contoured lumbar support pad provide additional comfort. Shoulder, hip, and crotch strap D-rings provide multiple locations for attaching accessories. Quick release buckles on the chest strap and at the bottoms of the shoulder straps make harness removal fast and easy. TransPacs are available in a full range of sizes and are easily adjustable to all body types.

The TransPlate harness is a hybrid design for divers who prefer a traditional metal backplate but want the support of a backpack style harness for better weight distribution. When used with a 6 pound steel backplate, divers can minimize or remove additional ballast weight.



Air Cell

The custom designed CCR XT wing comes standard on all O2ptimas. Providing 40 lbs of lift, the CCR XT wing was designed specifically for use with the O2ptima.

A 360 degree flow-through design allows gas to flow freely as the diver moves in the water. The wide center section puts the lift to the outside edges of the unit and prevents raising it off the center of the



diver's back. The over-the-shoulder inflator hose is located farther out on the divers shoulder so it will not interfere with loop hoses and counterlungs.

Abrasion resistant SuperFabric material is used on the back and side panels of the outerbag. The included adjustable bungee gusset control system can be used to contain excess material and maintain a streamlined profile when the wing is not fully inflated. Dual sets of grommets allow two height position options to fine tune trim.

An optional bailout bladder is available which provides redundant lift in case of a primary bladder failure.



An optional 10 lb trim pillow can also be installed in the bottom of the wing. The trim pillow helps divers maintain optimal horizontal trim even when wearing a wet suit or minimal exposure protection. The bailout bladder and trim pillow can be retrofitted on current CCR XT wings. Contact Dive Rite directly for these options.



Micropore ExtendAir Cartridge Overview

(Information from www.microporeinc.com)

ExtendAir® adsorbent technology is a combination of a microporous gas adsorbent sheet and the geometry in which it is utilized. The adsorbent material is manufactured with a proprietary process into a microporous sheet that can be made into different thicknesses and widths, using the same chemistry as in granular adsorbents.



Sheets of adsorbent material are wrapped around a core to form an

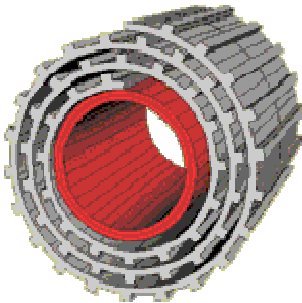

ExtendAir® cartridge. The molded ribs in the material create channels through which the breathing gases flow. One of the unique features of an ExtendAir® cartridge is that the breathing resistance of the adsorbent can be precisely controlled by varying rib height and spacing. This controlled channeling of the breathing gases results in a very uniform reaction zone within the adsorbent.

In a granular canister, gases seek the path of least resistance through the bed. The flow pattern can be very random and will certainly vary from person to person. Learning to load a granular canister requires instruction to learn the proper technique. Optimal loading of the canister requires tapping to achieve a uniform bed of granules. This takes time and can cause dusting of the adsorbent. All of this leads to variations in duration, wasted adsorbent and the potential for "caustic cocktail".



In contrast to a granular system, ExtendAir® cartridges use channels, molded in at the factory, that remain constant and controlled by the manufacturing



process. The user simply places the cartridge into the canister, without any need for tapping or shaking as the canister is being loaded. As such, the duration variability due to irregular granule settling patterns, as well as variability due to individual loading technique are completely eliminated. Eliminating this variability will directly translate into longer minimum duration, and a +/-5% variation in duration at any test condition (granules can vary up to +/-30%).

An important concept to understand with ExtendAir® cartridge technology is that the gas flow distribution through the cartridge must be uniform in order for the system to perform optimally. For example, one way to visualize flow through an ExtendAir® cartridge system is to take a bunch of soda straws in your hand (50 or so). What would happen if you blew air down through just a group of 5 straws? All of the air would flow down those five straws, and none of the air would flow through the other 45. The same thing would happen if you blew air into just one side of an ExtendAir® cartridge canister: all of the air would flow through that side only.



The end result of this uniform flow is full utilization of the adsorbent in the cartridge.

To achieve full adsorbent utilization, Micropore designs canisters to achieve a +/- 5% flow distribution at the inlet face of the ExtendAir® cartridge. This is accomplished through various engineering techniques such as diffusion screens and flow testing of the breathing loop. The result is a system engineered to perform consistently independent of individual loading techniques.

The combination of Micropore's ExtendAir® adsorbent manufacturing process, along with the parallel flow cartridge design, turns out to be extremely efficient. Installing an ExtendAir® Cartridge (EAC) is relatively simple, and takes seconds to perform. The O2 injection tube runs through the center of the EAC and with the use of a plug any possibility of "CO2 Channeling" is prevented.

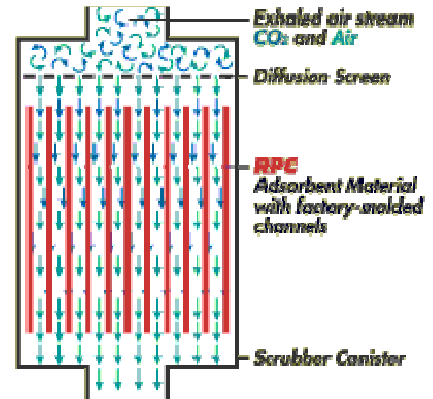



Assembling the O2ptima

This section will explain basic assembly procedures of the O2ptima. Units are delivered partially assembled. These instructions will serve as a guideline for correct initial assembly and also should disassembly be necessary for transportation or maintenance.

The Importance of Using Checklists

Many rebreather accidents and fatalities could have been prevented with the use of assembly and pre-dive checklists. There is nothing particularly difficult about assembling a rebreather, however there are many small yet important steps in the process. A small oversight such as forgetting to re-install an O-ring can have disastrous consequences.

We are all human and as such are susceptible to distraction and lapses in memory. There is overwhelming evidence pointing to the efficacy of checklists in preventing errors in complex technical procedures. It is highly recommended that you use a written or digital checklist for both assembly and pre-dive checks before every dive. See the **Checklists** section in this manual for assembly and pre-dive checklists.

Gas Analyzation

The most important rule of rebreather diving is to always know what gas is in the breathing loop. This process begins with analyzing the contents of your cylinders.

Sensor calibration is performed assuming a certain percentage of oxygen, however the only way to know what percentage of oxygen the cylinder actually contains is to analyze it. If the actual percentage of oxygen in the cylinder is different than what is assumed, it could lead to an incorrect calibration resulting in a different gas mix in the loop than what is displayed on the HUD and controller. This could result in oxygen toxicity or errors in decompression calculations.

It is highly recommended that both oxygen and diluent cylinders, along with any bailout cylinders, be analyzed and the contents labeled on the cylinder prior to assembling the unit.

Installing the Cylinders and Regulators

Begin by installing the filled and analyzed cylinders onto the stand. Lay the stand down and install the O2 cylinder (note the green handwheel) on the right hand side and the diluent cylinder on the left with the valves at the bottom, valve openings pointing away from the stand, and valve handwheels pointing straight out to the sides.

Before tightening the cylinder cam straps, install the first stage regulators on both cylinders. The green hoses designate the O2 first stage and black hoses designate the diluent first stage. Install the regulators with the hoses pointing up (See **Figure 1**).

With the regulators installed, adjust the height of the cylinder so that the first stage rests gently on the top surface of the foot or slightly above it. Tighten the cam straps and Velcro straps on the cylinders. Check to make sure that both cylinders are held securely and do not slide.



Route the hoses in between the cylinders as shown in **Figure 1**.



Figure 1 - Hose Routing

How to Install a Micropore ExtendAir Cartridge

The next step in the build process is to assemble and install the CO₂ scrubber canister. The O₂pitma can be used with either the Micropore ExtendAir cartridge or it can be packed with loose granular CO₂ absorbent. This section will deal with using the ExtendAir cartridge. If you are using loose granular absorbent, skip to the next section, **How to Pack the Scrubber**.

To use an ExtendAir cartridge, begin by inspecting all of the scrubber components. Look for any damage, dirt, debris, or excess lubrication on the scrubber canister, ExtendAir cartridge, scrubber end cap, electronics head, bore plug nut, and seals and O-rings. Any damage or contamination can cause a loss of water integrity and flooding of the breathing loop.

Next, remove the ExtendAir cartridge from its packaging and, using a permanent marker, mark the installation direction on the side and/or end of the cartridge. If the cartridge is removed between dives and then later reinstalled, it is critical that the cartridge be reinstalled in the same orientation to prevent premature CO₂ breakthrough (See **Figure 2**).



Figure 2 - Installing EAC



Install the cartridge by sliding it all the way into the canister. Next, install the bore plug nut with the tapered end toward the cartridge. This tapered end will seal against the center bore of the cartridge. Tighten until snug (See **Figure 3**). The included wave spring and top plate with screen are not used when using an ExtendAir cartridge. The canister is now ready to be installed on the unit.



Figure 3 - Bore Plug Installation for EAC

How to Pack the Scrubber

The scrubber canister can be packed with approximately 5 pounds of loose granular CO2 absorbent. Dive Rite recommends Intersorb 812 or Sofnolime 797 (8-12 mesh) granular absorbent. 408 (4-8 mesh) is not recommended. It is important to use fresh absorbent for every dive. Granular absorbent should never be reused.

To pack the scrubber, begin by inspecting all of the scrubber components. Look for any damage, dirt, debris, or excess lubrication on the scrubber canister, scrubber end cap, electronics head, bore plug nut, and seals and O-rings. Any damage or contamination can cause a loss of water integrity and flooding of the breathing loop.

Ensure that the stainless steel screen mesh is correctly seated in the bottom of the scrubber canister (See **Figure 4**).



Figure 4 - Screen Installed in Scrubber Canister

Begin pouring granular absorbent into the canister (See **Figure 5**).



Figure 5 - Pouring Scrubber Media

Fill the canister approximately half full and then tap around the outside of the canister to settle and level the absorbent (See **Figure 6**).



Tap sides of canister
to settle absorbent

Figure 6 - Tap to Settle

Continue filling with absorbent until it is approximately $\frac{1}{4}$ inch from the top of the canister. Again tap around the outside of the canister to continue settling and compacting the absorbent. If necessary, add more absorbent to bring the fill level back to $\frac{1}{4}$ " from the top of the canister.

Place the top plate with attached screen on top of the canister with the screen side down. It should be flush with the inside edge of the canister (See **Figure 7**). If it is not, add or remove absorbent and relevel until it is. Note—the wire handle on the top plate is only for removing the plate. It is not a carry handle for the scrubber.



Figure 7 - Proper Fill Level

Next, place the wave spring around the stainless steel center tube, on top of the top plate. Finally, orient the nut with the tapered side up and thread it onto the center tube (*Note that the nut is installed in one direction when using an EAC and the other direction for a packed scrubber). Make sure that the spring sits in the small counterbore in the nut. This keeps the spring centered on the top plate (See **Figure 8**). Tighten the nut to compress the wave spring against the top plate. Do not overtighten the nut.

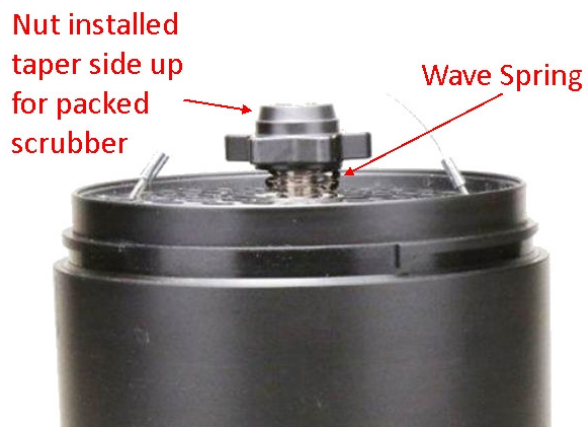

Figure 8 – Spring & Nut Orientation



Figure 9 - Nut Tightened

The nut and spring are not intended to apply pressure to “pack” the scrubber. They are only to ensure an even pressure is held on the top plate after properly packing it.

The canister is packed correctly if shaking the canister does not result in noise being heard from the absorbent. Any movement of the absorbent can lead to channeling and premature CO₂ breakthrough. If needed, remove the lid and continue tapping the sides of the canister and adding more material as necessary.

Clean up any excess absorbent dust before installing the scrubber canister. The dust will quickly react with any exposure to water and can create a caustic solution in the breathing loop.



Installing the Scrubber Assembly

With the ExtendAir cartridge installed or the scrubber packed, the next step is to install the canister onto the stand. It should be centered horizontally in the hood scoop with the perforated base side to the left and the open side to the right.

Rotate the canister to where the “locked” markings are oriented straight forward. This will place the counterlung fittings in the correct location once the head and end caps are installed (See **Figure 10**).

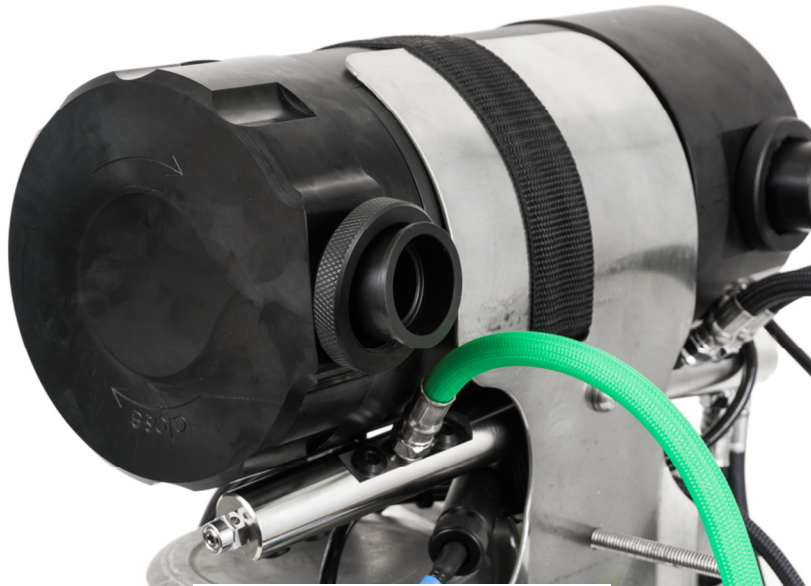

Figure 8 - Scrubber Canister Installation

With the canister in place, tighten the cam strap around the canister positioning the cam buckle low and close to the cylinders to prevent interference with the cover (See **Figure 11**).



Figure 9 - Cam Buckle Position



Installing the Electronics Head

Check that the orange electronics head O-rings and flat seal are clean and lubricated. Dive Rite recommends lubricating these seals with Tribolube 71 grease.

Confirm that the small orange O-ring is in place on the premix tube. The O-ring should be above the sensor disk. To ensure that it is in the right spot, lay your fingers on the disk and the O-ring should be above your fingers (See **Figure 12**). When the canister is installed it will push the O-ring down to seal against the stainless steel tube in the center of the canister.



Figure 10 - Premix Tube O-Ring

Install the head by inserting the premix tube into the center tube of the body (See **Figure 13**), aligning the arrows on the head and body, pushing the head into position, and then rotating clockwise until the head arrow is aligned with the "LOCKED" position (See **Figure 14**).



Figure 11 – Installing Electronics Head

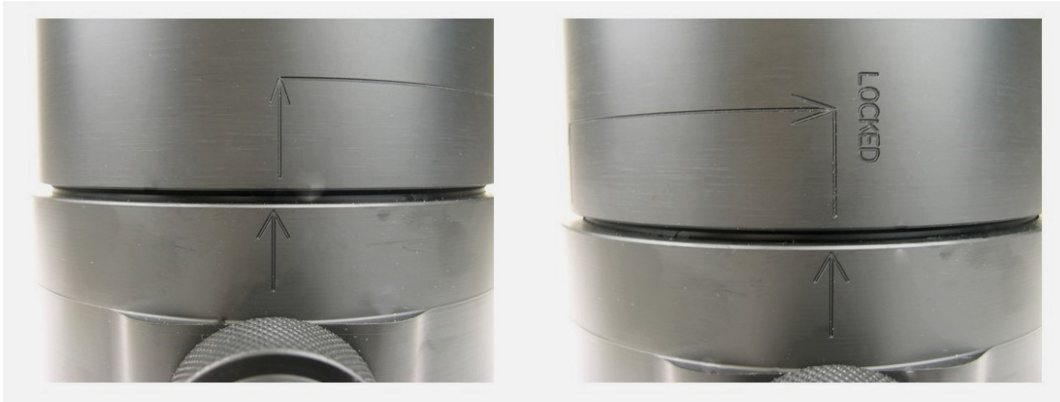

Figure 12 - Locked Position

Attach the LP oxygen injection supply hose to the head by threading it onto the fitting (See **Figure 15**). Do not overtighten. This fitting only needs to be finger tight.



Figure 13 - Install Oxygen Supply Hose

Installing the Scrubber End Cap & Water Trap

The cone shaped water trap snaps into the end cap and can be removed for maintenance and cleaning. There is a large orange O-ring sealing the edge of the water trap (See **Figure 16**).



Figure 14 - Water Trap Sealing O-ring



Clean and lightly lubricate this O-ring with Tribolube 71 and then snap the water trap into place. Next, clean, lubricate and install the large sealing O-ring (See **Figure 17**).



Figure 15 - Installing Water Trap & Large Sealing O-ring

There is a large orange flat seal that is pressed into the water trap. It is recommended not to remove this seal unless replacement is necessary as it is difficult to reinstall.

If the flat seal must be removed, reinstall the clean and lightly lubricated seal by pressing into place on opposite sides and then slowly, working back and forth, flattening it into the groove (See **Figure 18**).



Figure 16 - Inserting Flat Seal

Figure 19 shows the completed end cap assembly ready for installation.



Figure 17 - Complete End Cap Assembly



Installation of the end cap assembly is the same as for the electronics head—align the arrows, press into place, and rotate the end cap clockwise until the end cap arrow is aligned with the “LOCKED” position (See **Figure 20**).

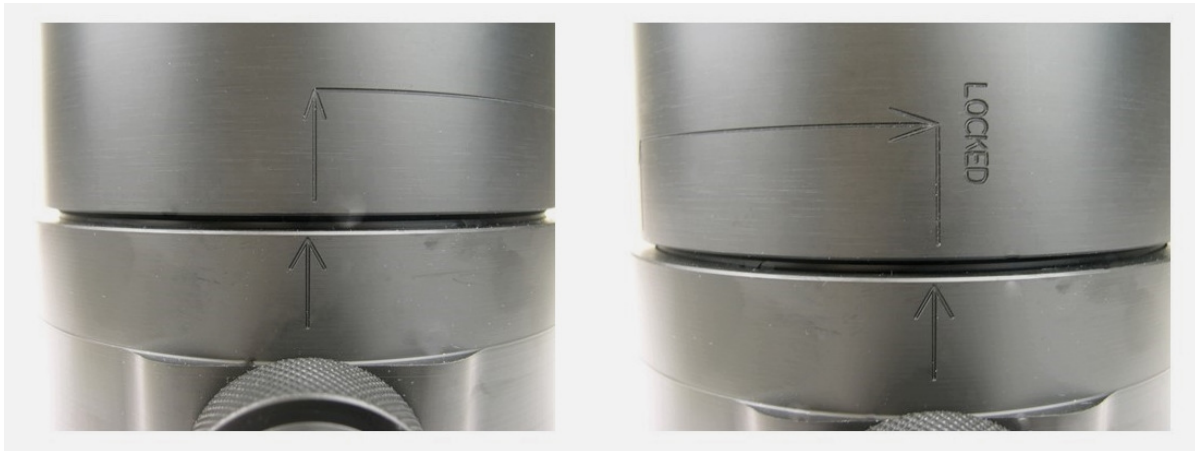

Figure 18 - Locked Position

With both the head and the end cap installed, it is possible to pressure test the canister by covering one of the loop hose fittings with your hand and blowing into the other. No air should escape. If you hear or feel air leaking, remove the head and lid and confirm that all seals and O-rings are installed and properly cleaned and lubricated.

Mounting the Electronics/Battery Canisters

The electronics/battery canisters are mounted in elastic sleeves located on the cylinder cam bands. The solenoid control canister is located on the left side and the HUD control canister is located on the right side. Carefully route the cables so that they are not pinched or kinked, and then insert the canisters into the elastic sleeves (See **Figure 21**).



Figure 19 - Electronics Canister Installed in Sleeve



Installing the Air Cell, Counterlungs, & Harness

The air cell installs on the front side of the O2ptima. The CCR XT has two grommet positions to allow two different height adjustments. This can help to fine tune trim by placing the lift higher or lower on your back.

Install the air cell by placing the grommets over the threaded posts. Next, route the remaining hoses through the center portion of the air cell with the exception of the manual addition supply hose and the BC inflator hose which route over the top of the wing as shown in **Figure 22**.



Figure 20 - Hose Routing Through Wing

The green oxygen hoses will route to the diver's right side, and the black diluent hoses will route to the divers left.

Next, install the counterlungs onto the threaded posts as shown in **Figure 23** routing the hoses as shown. Make sure the counterlungs are oriented with the OPV facing forward.

Press the fittings on the back of the counterlungs into the head and end cap fittings and then tighten the connector rings.



Figure 23 – Counterlung Installation

The harness or backplate can now be installed. Remove the lumbar pad if necessary to expose the grommet holes and install the harness over the same threaded posts as the air cell. Add a flat fender washer on top of each post and then add the wing nuts and tighten firmly by hand (See **Figure 24**). Replace the lumbar pad if desired.

It is important to only use the oversized fender washers supplied with the unit—smaller washers do not distribute the load as well and can cause the metal grommets to be pulled out of the material.



Figure 24 - Harness Installed with Fender Washers



Installing the Cover

Ensure that all hoses are routed properly and neatly tucked between the cylinders.

The Kydex cover has slots in both sides and the top for accessory weight pockets. If these are desired, install them before attaching the cover.

The Kydex cover can now be installed. Place the cover into position and use the plastic buckles to clip it into place.



Figure 25 – Cover Installed

There are two buckles at the top that clip into buckles sewn into the webbing handle at the top of the stand. There are two additional buckles on each side of the cover that clip into buckles on webbing straps weaved through the stand.

Once all buckles are clipped, pull the webbing tabs to snug the cover tight against the cylinders. The cover should not be loose (See **Figure 25**).

Installing the Loop Hoses

There are two hoses that connect the BOV to the counterlungs to complete the breathing loop. Each hose has counterlung fittings attached to the end.

Before installing the hoses, lightly lubricate the O-rings and sealing surfaces on the counterlung fittings with Tribolube 71.

Install the loop hoses by pressing them into place and tightening the threaded rings. (See **Figure 26**).



Figure 26 - Installing Loop Hoses

The oxygen and diluent low pressure hoses can now be routed along the loop hoses and connected to the BOV manual addition valves (See **Figure 27**). These connections are threaded on and only need to be hand tight. Install the HUD into the BOV HUD mount to complete the assembly of the unit.



Figure 27 - Installing Manual Addition Feed Lines



Basic Operation & Use



WARNING: This manual does NOT cover all information and procedures required to safely dive the O2ptima and is NOT a substitute for unit specific training.

Harness Size & Adjustment

Proper harness adjustment begins with selecting the correct size harness. Dive Rite offers Transpac and Transplate harnesses from XS through XXL. Your T-shirt size is usually a good starting point, but for more accurate sizing, use the sizing chart available at www.diverite.com or contact Dive Rite directly. We have the ability to fit a wide variety of body types and sizes.

To properly adjust the harness, refer to the instruction documents that came with your harness. Your instructor should also help to make sure the harness is properly fitted to you.

Adding Trim Weights

Trim weight or additional ballast weight can be easily added to the O2ptima in several places. There are slots on either side as well as the top of the Kydex cover that allow the addition of weight pockets. It is also possible to put weight pockets onto the waist belt of the harness. Your instructor will work with you to ensure you are properly weighted for safety and proper horizontal trim in the water.

Oxygen Sensor Calibration

Oxygen sensor calibration should be confirmed prior to every dive and recalibrated as needed. Begin by disconnecting the counterlungs from the scrubber canister. Next insert the supplied calibration caps by pressing them into the fittings on the electronics head and end cap. The cap with the mushroom exhaust valve should be inserted into the electronics head fitting, and the cap with the BC fitting inserted into the end cap fitting.

With the oxygen cylinder valve turned off, disconnect the green oxygen hose from the manual add valve and connect it to the calibration cap as shown in **Figure 28**.



Figure 28 - Calibration Caps

Turn on the Petrel 2 controller and HUD.

While watching the PPO2 values on the controller and HUD, turn on the oxygen cylinder valve in short bursts a couple of seconds apart. The PPO2 values on all sensors should climb as oxygen is added. Continue adding oxygen until all sensor values stabilize and do not continue to increase.

Once all values have stabilized at their maximum value, perform the calibration. See the **Shearwater Petrel Dive CAN Rebreather Controller Model Operations Manual** and the **Shearwater HUD User Manual** respectively for specific calibration instructions.

It is recommended to calibrate using 100% O₂ if available, however it is possible to calibrate the controller using as low as 70% O₂ if that is all that is available. If using a calibration gas less than 100% O₂, the calibration FO₂ setting will need to be adjusted in the controller first. See the **Shearwater Petrel Dive CAN Rebreather Controller Model Operations Manual** for more information on this.

BOV Operation

The purpose of the BOV (Bail Out Valve) is to produce a one way flow of gas through the breathing loop when in closed circuit mode. This is accomplished through the use of two one-way mushroom valves. When the diver inhales, the exhale valve closes and the inhale valve opens. When the diver exhales, the inhale valve closes and the exhale valve opens. It is extremely important that the integrity of the mushroom valves be maintained.

Any time the diver is not actively breathing on the loop, the BOV should be closed by rotating the knob on the front to the vertical or open circuit “bail out” position. This closes the breathing loop while still allowing open circuit breathing from the diluent tank. It is important to do this before removing the mouthpiece from your mouth while underwater, or on the surface, to prevent water from entering the breathing loop and flooding the unit. Minor amounts of water in the loop can be dealt with by flushing it out of the exhalation counterlung OPV (this is a skill you will learn in class), however a major flood will not be recoverable during the dive and will require bailing out using the onboard BOV or an independent open circuit system.

If you are switching back to the BOV from a different breathing source while underwater, you will need to clear the small amount of water in your mouth and the mouthpiece before opening the BOV. Do this by exhaling through the BOV mouthpiece before turning the knob back to the horizontal or closed circuit position.



Breathing on the Loop

The number #1 rule for diving a rebreather is to **ALWAYS KNOW YOUR PPO2!** This can be monitored using the HUD and/or the controller. It is important to check both often and confirm that the PPO2 values agree. If you cannot read the PPO2 values or if for any reason you are unsure of the true PPO2 in the loop you must bail out to an independent, open circuit bailout system.

It is important to remember that YOU are the engine that drives the breathing gas through the loop. You are using your lungs to push and pull gas through the unit. Proper functioning depends on this constant flow of gas. Breathing should be slow, deep, and continuous with no pauses. Pausing between breaths can cause PPO2 spikes because injected O2 does not flow across the sensors without the gas being “pushed” across them. If the injected O2 does not reach the sensors quickly enough, the controller will continue to add more O2 to try to maintain the setpoint. This can cause more O2 than necessary to be injected and lead to a spike once breathing is resumed and all of the injected oxygen hits the sensors at once.

It is also important to exhale completely to prevent CO2 buildup in your body. Shallow breathing does a poor job of expelling CO2 and can lead to hypercapnia. Breathing too fast can also be problematic as this does not allow proper dwell time of the exhaled gas in the scrubber (commonly referred to as “over breathing” the scrubber). Strive for a slow, steady breathing rhythm.

It is best to maintain a minimal loop volume when diving. This is achieved when a full inhalation does not quite trigger the ADV. Too much gas in the loop can have a negative effect on breathing effort and buoyancy control.

Electronic vs Manual Operation

The O2ptima is a fully electronics controlled rebreather (eCCR), but it is also capable of manual operation (mCCR). When using the O2ptima in eCCR mode, the controller is analyzing the oxygen sensor values in real time and determining when and how long to fire the oxygen injection solenoid in order to maintain the user adjustable PPO2 setpoint. When all systems are functioning properly, the diver will not have to manually add any gas to maintain a breathable loop.

It is important to keep in mind that the rebreather is only a machine. The controller is taking readings from the oxygen sensors, and making determinations based on those readings. If the values that the sensors are providing are not accurate, then the end result will not be accurate either. There are a variety of reasons that the oxygen sensor values may not accurately reflect the actual PPO2 of the gas in the breathing loop. Some of these reasons can be aging, damaged, or current limited sensors, wiring harness or electronics issues, water or other contamination on the face of the sensors, and improper breathing of the diver.

Because of this, it is up to the diver to monitor the HUD and controller, interpret the information provided, and take action if necessary. All of these issues and the correct responses to take will be covered by your instructor during class. The most important things to keep in mind are that the rebreather cannot think for you, and “when in doubt, bail out!”

The O2ptima can also be used manually. In this case the diver monitors the PPO2 readings on the HUD and controller, and manually injects oxygen into the breathing loop by pressing the manual addition valve on the exhalation counterlung. This gives the diver complete control over the PPO2 in the loop.



There are several scenarios in which the diver might choose to use manual control such as a solenoid failure or partial electronics failure.

It is also possible to keep the O2ptima in eCCR mode, but lower the PPO2 setpoint, and then manually inject oxygen to maintain a higher setpoint. In this way the user is operating the unit manually with the electronics functioning as a sort of “parachute” in case the diver becomes distracted or is unable to manually add oxygen.

All of these scenarios and operation modes will be covered in your training class.

Dive Rite recommends diving the O2ptima with a PPO2 setpoint of between 0.7 and 1.2 depending on the dive. Diving at PPO2s higher than 1.2 can increase the risks of oxygen toxicity.

Diluent Injection

Diluent is injected into the breathing loop in one of two ways—either automatically through the ADV, or manually by pressing the manual addition valve on the BOV.

The ADV functionality is built into the BOV and uses a demand valve which functions similarly to a standard 2nd stage. If the counterlungs fully collapse when the diver inhales, the negative pressure on the ADV diaphragm will cause the valve to open and add diluent. This allows the diver to take a full breath even if the counterlungs are “bottomed out.” This can be especially useful on descent where the loop volume is decreasing due to increasing water pressure.

Manually injecting diluent is also an option in case the ADV does not function properly or is turned off. Manual diluent injection is also used to perform a diluent flush. These skills will be covered in your class.

Servicing, Maintenance, & Cleaning

In order for the O2ptima to continue to perform properly, it must be cleaned and maintained regularly. Rebreathers require more maintenance and cleaning than standard open circuit SCUBA equipment. For their own safety, a rebreather diver should be committed to spending the time, effort, and money required to properly maintain the unit.

Post Dive Procedures and Cleaning

There are several things that should be done as soon as possible after the dive is over.

First, close the BOV and change your set point to 0.19 PPO2 on the controller. This will prevent the unit from firing the solenoid and wasting oxygen when the unit is not in use.

Next, it is good to check the battery voltages to know if the batteries will need replacing before the next dive.

Also, note the pressure remaining in the oxygen and diluent cylinders, and the total dive time to determine scrubber usage.



The cylinder valves can now be closed and the lines purged by pressing the manual add buttons. **(***Never turn off the cylinder valves before you are out of the water and have removed the rebreather! ***)**

If the unit was dived in salt water, soak it in a freshwater tank if possible and then spray it off thoroughly with fresh water.

Turn off the controller and HUD to maintain battery life. Make sure the electronics do not come back on automatically due to the wet switch.

This is all that is needed if the unit will be dived again that day. Otherwise, the breathing loop should be disassembled and sterilized. It is recommended to do this within 12 hours after diving to prevent the growth of mold and bacteria in the loop.

Begin the cleaning procedure by disassembling the loop. Remove the BOV, loop hoses, counterlungs, scrubber end cap, and scrubber canister.

It is not necessary to remove the electronics head from the unit for cleaning. Simply wipe down the inside of the head with a clean towel and allow it to dry.

Remove the EAC scrubber cartridge or granular media and discard. All of the other pieces of the loop can now be thoroughly flushed under warm running water paying special attention to the inside of the exhalation side hose and counterlung.

Next, mix up a solution of Steramine in a bucket according to the directions on the bottle. Submerge all loop parts except for the electronics head and the counterlungs in the solution for a minimum of 1 minute to sterilize. Do not leave them in the solution for an extended period of time, as over exposure to the chemicals can damage mushroom valves and seals.

Once sterilized, remove the parts from the solution and thoroughly rinse inside and out with fresh warm water.

To sterilize the counterlungs use a cup to pour some of the Steramine solution into each counterlung. Cover the opening and shake the counterlung for 1 minute, then dump and rinse the inside thoroughly with fresh warm water.

Shake excess water off of all the components and then spread them out on a clean towel to dry. Hang the counterlungs to dry with the opening pointed downwards.

For reference, see the Post Dive Checklist in the **Checklists** section.

Oxygen Sensor Care

Oxygen sensors are the Achilles' heel of all modern rebreathers. Sensors have a finite life span and should be considered consumable items. They are prone to failure and it is important to know how and why they can fail.

Oxygen sensors are essentially oxygen powered galvanic fuel cells. They are electrochemical devices that produce a weak electric current in the presence of oxygen. Over time, the chemicals are slowly consumed and the sensor becomes increasingly unreliable.

A new sensor will have a linear response to the partial pressure of oxygen throughout the normal operating range used in rebreather diving. However, as they age, their output becomes increasingly



non-linear at higher partial pressures of oxygen. This is commonly referred to as “current limiting.” The problem with this is that a sensor may appear to be acting normally, but display a lower PPO₂ than what is actually in the breathing loop. If the diver (or electronic controller) is using this value to determine oxygen injection it can quickly lead to a hyperoxic breathing loop.

This is the primary reason for having multiple oxygen sensors. It allows the diver (or controller) to look at all sensor values simultaneously and easily determine if one is giving a different reading from the rest. If a discrepancy occurs, the diver has several options available to determine which sensors are reading correctly and which should be ignored. These procedures will be covered in your training. Any sensors that are suspected of being current limited must be replaced before diving the unit.

The response time of aging sensors will also slowly increase. If you notice one or more sensors responding slowly to changes in PPO₂ compared to the other sensors, they should be replaced.

Many rebreather fatalities have occurred because of using old sensors. Dive Rite recommends that sensors be used for no more than 12 months. The clock starts ticking as soon as the sensor is removed from the original packaging. The 12 month limit is independent of the number of dives on the unit. Even if the rebreather is stored and unused for a long period of time, the sensors should still be replaced prior to diving if they have been installed for more than 12 months.

Even unused sensors still in their original packaging have a limited shelf life. Dive Rite uses Analytical Industries, Inc., sensors which have a “Sell by” date of 4 months after manufacture and a “Do not use after” date of 16 months after manufacture. Even if the sensor has been in use for less than 12 months and seems to be working correctly, it should be discarded and replaced once the “Do not use after” date is reached.

Because of the limited shelf life, it is recommended that you do not keep a large stock of “backup” sensors. It is much better to purchase fresh sensors as they are needed.

There are different theories about the best replacement schedule for sensors. Many divers opt to replace all four sensors at once during the annual service every year.

An alternative replacement schedule is to replace one sensor every 3 months. The sensor that is replaced should either be the oldest of the set, or alternatively the one that is the slowest to respond to PPO₂ changes. This method has the advantage that each sensor will be from a different manufacturing batch. Although rare, it is possible for an entire batch of sensors to be defective and fail prematurely. The age of the sensors will also be staggered with this method and will lessen the chance that multiple sensors will fail at the same time.

Replacing sensors in a timely manner will mitigate a lot of the potential issues, however it is possible for sensors to fail before their expiration date is reached. Even brand new sensors can fail. It is always best to keep a close eye on your HUD and controller for any discrepancies and replace any suspect sensors immediately.

Sensors should not be removed from the unit for storage in between dives. This practice is unnecessary and can lead to damaged sensors and increased wear and tear on the wiring harness.

Sensors should never be frozen, vacuum sealed, or stored in inert gas or desiccant in an attempt to increase their life span. Any of these practices will likely damage the sensor. Sensors, along with the rest of the rebreather, are best stored in a cool (but not freezing), dry location out of direct sunlight.

For more information on oxygen sensors see Appendix II: **Galvanic Oxygen Sensors Applied to Closed Circuit Rebreathers** by Analytical Industries, Inc. and Analytical Industries, Inc. (www.aii1.com)



Oxygen Sensor Replacement

To replace a sensor, remove the screw holding the sensor plate in place (See **Figure 29**).

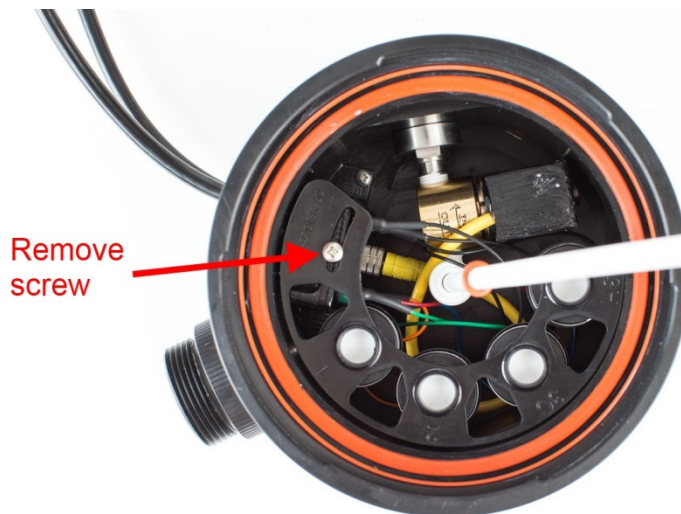

Figure 29 - Sensor Plate Screw

Lift the sensor plate and carefully unplug the sensor to be replaced at the back of the sensor. Lift the connector tab to remove—do not pull on the wires (See **Figure 30**).

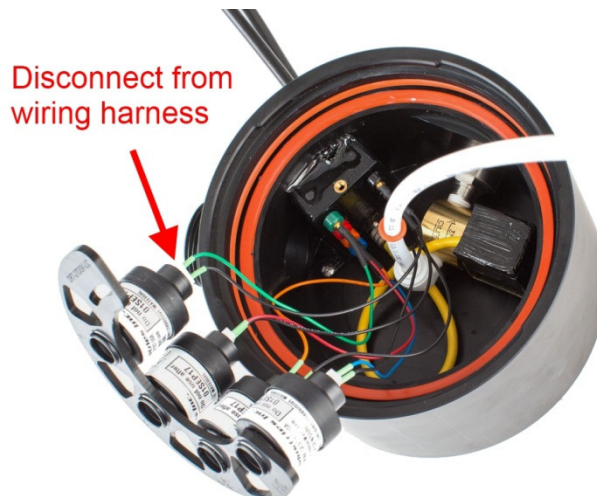

Figure 30 – Oxygen Sensor Wiring Harness

The sensors are threaded into the sensor plate. Remove the sensor by turning it counterclockwise (See **Figure 31**).



Figure 31 - Sensor Removal

Install the new sensor by threading it into the plate. Finger tight is fine; do not over tighten. The front edge of the sensor should protrude slightly past the surface of the sensor plate (See **Figure 32**). This is intentional and encourages any water condensation on the sensor plate to drip off instead of easily running into the sensors.

Plug the wiring harness into the sensor verifying the sensor position number on the sensor plate corresponds to the correct wire at the connector block.

Finally, reinstall the sensor plate with the sensor plate screw.

Once the sensor is installed, perform an oxygen flush and calibration (See the **Oxygen Sensor Calibration** section). Verify that the sensor is reading correctly before diving.

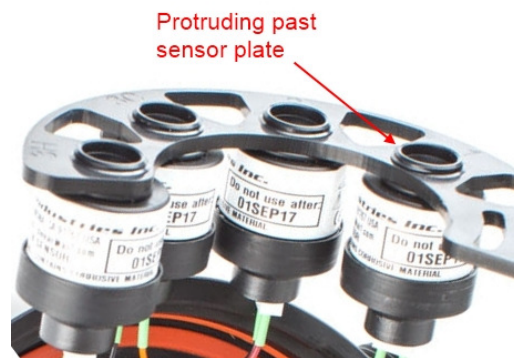

Figure 32 - Sensors Installed



Battery Replacement

There are 3 batteries on the O2ptima. The first is the internal battery located inside the controller. The controller displays this battery voltage in yellow when the battery is low and needs replacement. It will display flashing red when the battery is critically low and must be replaced as soon as possible. To replace this battery, see the **Changing the Battery** section of the **Shearwater Petrel Dive CAN Rebreather Controller Model Operations Manual**.

The other two batteries are located inside the external electronics/battery canisters. The canister on the (diver's) left side of the unit houses the battery that powers the SOLO board as well as the solenoid. This battery is a standard 9 volt battery.

The external battery voltage for the SOLO/solenoid battery can also be checked on the controller. This voltage is only checked when the solenoid is fired, so if the solenoid has not yet fired the value is unknown and displays as a yellow "?". If this is the case, adjust the controller setpoint to a higher PO2 and allow the solenoid to fire for several seconds and then recheck the voltage.

The canister on the (diver's) right side of the unit contains the battery which powers the OBOE board and HUD. This battery is a standard AA type. The HUD does not have its own battery—it only receives power from the OBOE board.

A low OBOE/HUD battery voltage will be displayed on the HUD. After turn on, the yellow row of LEDs will remain on for 30 seconds to indicate a low battery that should be replaced.

A high quality alkaline 9V battery will typically provide approximately 50-60 hours of dive time before needing replacement. However, there is a slight battery drain at all times when the batteries are in place even if the HUD and controller are turned off. If the unit is stored for an extended period of time with the batteries in place, the batteries may need replacing even if the unit has not been used.

Typically, the SOLO/solenoid 9V battery will need changing more frequently than the OBOE/HUD AA battery. Dive Rite recommends changing both batteries at the same time once either one indicates a low battery voltage. Rechargeable batteries are not recommended for use in these locations. Only high quality, name brand batteries are recommended. It is important to remember that this is **LIFE SUPPORT** equipment—this is not the place to be cheap on batteries. For the correct replacement batteries, please see the **Battery Recommendations** section below.

To replace either of the external canister batteries, begin by unscrewing the cap on the end of the canister. While unscrewing the cap, hold the canister with the cap pointed down. This will prevent any residual water that might be located on the sealing O-rings or cap threads from running down into the canister and damaging the electronics (see **Figure 33**). With the cap removed, carefully dry any excess water before proceeding.

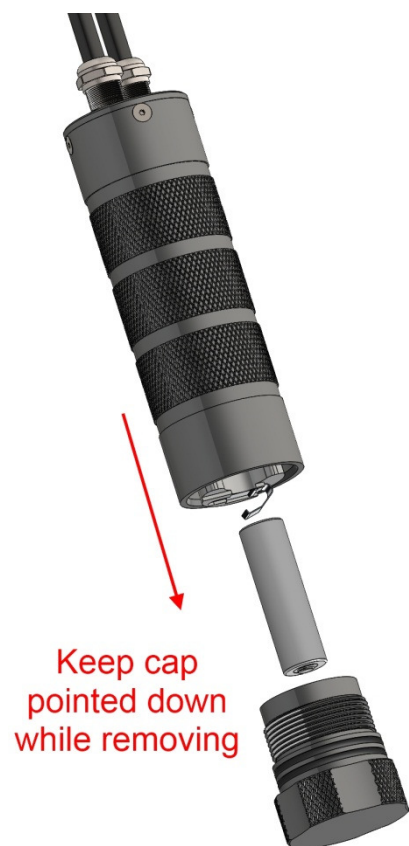

Figure 33 - Cap Removal & Battery Replacement



The battery can now be replaced paying special attention to the “+” and “-” orientation as marked on the canister.

Inspect the canister O-rings before reinstalling the cap. They should be clean and undamaged. If needed, carefully remove the O-rings and wipe them clean along with the O-ring grooves on the cap. Lightly lubricate the O-rings with a silicone grease such as Dow Corning Molykote 111.

With the O-rings correctly in place, reinstall the canister cap by threading it into the body. The cap only needs to be hand tight. Do not over tighten.

Battery Recommendations

Battery Location	Battery Type	Recommended Batteries	Acceptable Alternatives
Petrel 2 Controller (Internal)	AA	<ul style="list-style-type: none"> Duracell Coppertop or equivalent high quality AA 1.5V Alkaline 	<ul style="list-style-type: none"> Saft 3.6V LS14500 3.7V Li-Ion 14500 rechargeable (AW brand is preferred) 1.2V Ni-MH rechargeable Photo Lithium 1.5V (recommended for cold water use) Low cost Zinc-Carbon 1.5V batteries will work, but are not recommended due to poor performance and short life
SOLO/Solenoid External Canister	9V	<ul style="list-style-type: none"> Ultralife 9V Lithium¹ 	<ul style="list-style-type: none"> Duracell Coppertop or equivalent high quality 9V Alkaline¹ <p>*** Rechargeable batteries are NOT recommended***</p>
OBOE/HUD External Canister	AA	<ul style="list-style-type: none"> Energizer Ultimate Lithium AA 	<ul style="list-style-type: none"> Saft 3.6V LS14500 Duracell Coppertop or equivalent high quality AA 1.5V Alkaline <p>***Rechargeable batteries are NOT recommended***</p>

¹Note: Not all 9V batteries are the same size. Some brands will not fit correctly into the battery canister. Confirm that the battery fits loosely into the cap before inserting the battery and tightening the cap. Failure to do this can lead to damage of internal components.

Storage

If you plan to store your O2ptima without use for an extended period of time there are several steps you should take to protect the unit.

First, remove all batteries from the unit. This includes the AA battery in the Petrel 2 controller, the 9V battery in the SOLO/solenoid external canister, and the AA battery in the OBOE/HUD external canister. There is a slight current draw on the batteries even when the unit is turned off. Also, alkaline batteries tend to leak when they are fully discharged.



You will want to perform a thorough cleaning and sterilization of the entire breathing loop and then allow it to dry completely in pieces before storage.

Store all pieces in a sealed box and/or a plastic bag to keep bugs from getting inside of the components. The unit should be stored in a cool, dry environment away from direct sunlight.

It is not recommended to remove the oxygen sensors for storage. However, all sensor dates should be inspected after a long period of storage to ensure that they have not expired. Replace any expired sensors, install fresh batteries, and perform a sensor calibration before diving the unit.

Annual Service

Once every year you should return your O2ptima to Dive Rite or an approved Dive Rite O2ptima service center for an annual service. This service includes replacement of O-rings, loop hoses, and oxygen sensors, along with a rebuild of the BOV and regulators, and checks of the electronics to confirm correct operation and up to date firmware. This is not a user permitted service. It must be performed by an authorized service center.

Recommended Care Products

Use	Description
Divesoft BOV Lubrication	DuPont Krytox 201
Dive Rite DSV Lubrication	Aerospace Lubricants Tribolube 71
LP and HP Hose O-ring Lubrication	Aerospace Lubricants Tribolube 71
Loop Hose O-ring Lubrication	Aerospace Lubricants Tribolube 71 or Dow Corning Molykote 111
HUD & Controller Connector Lubrication	Dow Corning Molykote 111
Electronics/Battery Canister Lid O-ring Lubrication	Dow Corning Molykote 111
Breathing Loop Disinfectant	Steramine Sanitizing Tablets diluted in fresh tap water according to the packaging directions
General Cleaning (rinsing saltwater, etc.)	Fresh tap water

Technical Specifications

Weight	39 lbs 3 oz (17.8 kg) without cylinders or scrubber media
Oxygen Cylinder	Aluminum 20cf (3L) Cylinder (standard) Steel LP27 (4L) Cylinder (optional)
Diluent Cylinder	Aluminum 20cf (3L) Cylinder - standard Steel LP27 (4L) Cylinder - optional



Oxygen 1 st Stage Intermediate Pressure	85 psi
Diluent 1 st Stage Intermediate Pressure	140 psi
Batteries	Petrel 2 Controller (Internal): AA SOLO/Solenoid External Canister: 9V OBOE/HUD External Canister: AA
Counterlung Volume	6.5 Liter Total Loop Volume
Maximum Operational Depth	Max Depth 40 m (130 fsw) with Air diluent Max Depth 100 m (330 fsw) with Trimix diluent *Dives exceeding 100 m (330 fsw) are associated with numerous additional risks
Operating Temperatures	+39°F to +90°F (+4°C to +32°C)
Short-Term (hours) Temperature Range	-4°F to +122°F (-20°C to +50°C)
Long-Term Storage Temperature Range	+41°F to +68°F (+5°C to +20°C)
Oxygen Sensors	Analytical Industries, Inc. type R22D sensors (X 4)
Oxygen Sensor Operational Voltages	8 – 14 mV in air @ sea level 40 – 65 mV in pure oxygen @ sea level
Oxygen PPO2 Setpoint Range	0.5 – 1.5 PPO2 during dive mode (0.19 PPO2 available in surface mode only)
Water Traps	2 water traps—one located inside the scrubber lid and one inside the exhaust counterlung bladder
Electronics	Shearwater DiveCAN Petrel 2 Controller Sherwater DiveCAN HUD (Shearwater NERD optional)
Scrubber Media	Micropore ExtendAir Cartridges (EACs) or granular scrubber media: Intersorb 812 or Sofnolime 797 (8-12 mesh)
Granular Scrubber Capacity	Approximately 5 lbs (2.2 kg) (will vary slightly depending upon granular type and packing method)
Scrubber Duration	Micropore ExtendAir Cartridge: <ul style="list-style-type: none"> • 180 liters of CO₂ @ < 50 deg F [<10 C] (130 minutes @ 1.35lpm CO₂) • 240 liters of CO₂ @ 50-70 deg F [10-20C] (180 minutes @ 1.35lpm CO₂) • 300 liters of CO₂ @ >70 deg F [>20C] (220 minutes @ 1.35lpm CO₂) Test Parameters: <ul style="list-style-type: none"> • 40 lpm RMV • 1.35lpm CO₂ • 130 fsw (40 m) depth *Granular duration may be similar, but can vary greatly depending upon the type of granular and packing technique



Revisions & Changes in Documentation

Revision	Date	Description
A	3/2/18	Original document
B	1/3/20	Added note re: 9V battery fit

Checklists

Checklists are provided on the following pages. Note that there is a “Assembly Guide Checklist” and also a “Survival Checklist.” These are redundant. The “Assembly Guide Checklist” is intended as a complete assembly checklist to be used by students in training, or anyone who has not used the rebreather for a period of time and would like a detailed assembly checklist to follow. Some divers will choose to use this list exclusively and print out multiple copies to use as their dive log.

The “Survival Checklist” is intended for users who are thoroughly familiar with assembling and operating the O2ptima and are actively using it. It provides a condensed list of the critical checks that must be performed before every dive. If multiple dives are performed in a single day, this list should be used before every dive.

The “Preflight Checklist” is intended to be performed after gearing up and just before entering the water to begin your dive. It will confirm that all systems are turned on and functioning properly. It is recommended to attach a copy of this checklist to the O2ptima in a convenient location.

The “Post Dive Checklist” should be used after the dive is over. There are two sections to this list. The first is things that should be done immediately after every dive after getting out of the water, and the second is things that should be performed at the end of your day of diving.

O2ptima BMCL Assembly Guide Checklist

Date _____ Dive Location _____ Dive Buddy _____

1. ___ Fill oxygen, diluent, and bailout cylinders if needed.
2. ___ Analyze gas: Oxygen _____% O₂, Diluent _____% O₂ / _____% He,
Bailout 1 _____% O₂ / _____% He, Bailout 2 _____% O₂ / _____% He
3. ___ Analyze CO: Oxygen _____ PPM, Diluent _____ PPM, Bailout 1 _____ PPM, Bailout 2 _____ PPM
4. ___ Turn on handset and check O₂ sensor display in ambient air. Record mV readings: 1) _____ 2) _____ 3) _____
Readings should be between 8 and 14 mV.
5. ___ Change to low setpoint to fire O₂ solenoid. Check voltage: Ext. _____ V (min 7.6V) Int. _____ V (min depends on type of battery used) Change setpoint back to .19.
6. ___ Check HUD O₂ sensor display in ambient air and ensure that the reading agrees with the handset.
7. ___ Mount oxygen and diluent cylinders, attach regulators, and route hoses.
8. ___ Steramine and rinse canister, lid, loop hoses, DSV, and counterlungs unless completed before storage.
9. ___ Inspect canister, head, and lid. Is scrubber: EAC _____ Sorb _____ (type: _____)
New _____ Used _____ (_____ min)
10. ___ If using sorb, pack scrubber canister. If using EAC, inspect cartridge for damage, mark/note cartridge direction and install cartridge. Inspect bore plug and confirm that it is installed in correct orientation.
11. ___ Lube head O-rings and flat seal as necessary. Confirm O-ring is in place on premix tube and install head onto canister.
12. ___ Confirm water trap is installed in lid. Lube lid O-rings and flat seal as necessary. Install lid onto canister.
13. ___ Install assembled canister onto stand.
14. ___ Confirm solenoid oxygen supply hose is securely attached and electronics canisters are plugged in.
15. ___ Pressure test canister. If good, ensure hoses are routed correctly and install back cover. Install trim weights if needed.
16. ___ Install calibration caps, connect O₂ hose, turn on controller, and flush with oxygen until PPO₂ readings stabilize.
17. ___ Check and record mV readings while filled with O₂. Minimum 40 mV. Check for stability.
1) _____ 2) _____ 3) _____
18. ___ Turn on HUD to check operation at 1.0 PPO₂. Calibrate controller and/or HUD if required.
19. ___ Inspect loop, fittings, O-rings, and counterlungs. Lube as needed. Install counterlungs. Assemble counterlungs to head and lid.
20. ___ Inspect BOV and mouthpiece. Attach BOV to loop hoses, close BOV and confirm correct flow direction through loop.
21. ___ Connect loop to counterlungs. Double check all loop fittings for tightness. Route controller and HUD cables.
22. ___ Attach BC hose and manual add feeds to BOV.
23. ___ Perform negative pressure test for a minimum of 30 seconds.
24. ___ Perform positive pressure test for a minimum of 2 minutes.
25. ___ Turn on oxygen and diluent cylinders. Open counterlung exhaust valve. Check ADV, manual add valves, trim pillow inflator, BC inflator and exhaust valves/OPVs for proper operation.
26. ___ Record oxygen and diluent cylinder pressures: Oxygen _____ bar, Diluent _____ bar
27. ___ Turn off cylinders and perform a leak down check.
28. ___ Turn oxygen and diluent cylinders back on, change setpoint to 0.5, and perform a 5 minute pre-breath confirming correct solenoid operation.
29. ___ Confirm correct onboard & bailout gases are configured and selected in computers and that they are set to CCmode.
30. ___ Check bailout regulator hoses, mouthpieces, and hose fitting tightness. Install bailout regulators. Confirm IP as needed.

Survival Checklist

- Confirm scrubber media, bore plug, and premix tubing O-ring are correctly installed
- Confirm diluent and oxygen cylinder contents and pressures
- Perform leak down check on both diluent and oxygen systems
- Conduct positive and negative checks
- Check internal and external voltages and mV readings in air
- Flush with O₂, check mV readings, and confirm calibration on HUD and controller
- Complete the Preflight Checklist before diving

Preflight Checklist

- Turn cylinders on, check manual addition valves, verify pressures
- Confirm ADV function
- Verify handsets/HUD
- Prebreathe, verify set point, confirm PO₂
- Confirm BCD/Dry suit function(s)
- Don/verify operational use of bailout – check pressures

ALWAYS PERFORM BUBBLE CHECK

***** ALWAYS KNOW YOUR PO₂ *****

Post Dive Checklist

Immediately Post Dive

- Close the BOV
- Change set point to 0.19 PO₂
- Check battery voltages
- Note pressure remaining in oxygen & diluent cylinders and total dive time to determine scrubber usage
- Close cylinder valves and bleed down system via manual add valves (*****Never turn off the cylinder valves before you are out of the water and have removed the rebreather!*****)
- Dry electrical contacts on HUD then turn off HUD and controller

End of the Day

- Rinse and/or soak entire CCR in fresh water
- Unplug and remove HUD and controller
- Discard scrubber media/remove EAC (record scrubber usage and seal airtight if planning to reuse)
- Disassemble loop—remove BOV, loop hoses, counterlungs, scrubber end cap, and scrubber canister
- Wipe inside of electronics head with clean towel and allow to air dry
- Flush the inside of all loop components (except electronics head) with warm running water
- Soak loop hoses, BOV, scrubber canister, and scrubber end cap/water trap assembly in Steramine solution
- Pour Steramine solution into counterlungs, shake, and drain
- Rinse all loop components—including the insides of counterlungs—thoroughly with fresh water and shake/blow out excess
- Hang hoses, BOV, and counterlungs upside down to dry
- Allow all components to dry thoroughly before storage
- For long term storage, remove batteries and seal all components in plastic bag or bin after drying

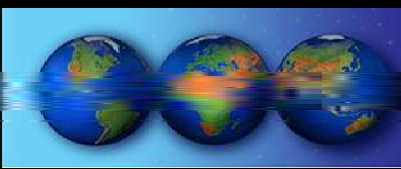

Galvanic Oxygen Sensors Applied to Closed Circuit Rebreathers

Company Profile

Analytical Industries Inc. was founded by individuals whose experience included the development (original and recent patents), pioneering the application of electrochemical galvanic sensors and refining the manufacturing process. Formed in 1994, Analytical Industries Inc. started with a clean sheet of paper, 60 years of experience and devoted their first year to R&D with the objective of advancing existing sensor technology.

The result provided Analytical Industries with competitive advantages in terms of sensor performance, life and reliability. Combined with uncompromising standards for quality, customer support and service Analytical Industries Inc. has become a recognized worldwide supplier of electrochemical oxygen sensors to the industrial, medical and diving industries.

Following this strategy, Analytical Industries Inc. and their Advanced Instruments business unit has become the preferred supplier of electrochemical based oxygen analyzers to global companies in the field of industrial gases, petrochemical products, natural gas, beverages, metals, ventilators, anesthesia machines, diving and rebreathers, the latter includes supplying the U.S. Navy with O₂ sensors for the MK16 rebreather since 1998.

Principles of the Galvanic Oxygen Sensor

Materials: Membranes sealed to a plastic body encapsulate anode, cathode and a base electrolyte. Wires conduct outputs from anode (-) and cathode (+) via an external circuit typically a PCB. The PCB consists of various electrical connectors, a resistor-thermistor temperature compensation network and is attached to the rear of the sensor.

Operation: The galvanic fuel cell sensor is actually an electrochemical transducer which generates a current (μA) signal output that is both proportional and linear to the partial pressure of oxygen in the sample gas. Oxygen diffuses through the front sensing membrane and reaches the cathode where it is reduced by electrons furnished by the simultaneous oxidation of the anode. The flow of electrons from anode to cathode via the external circuit results in a measurable current proportional to the partial pressure of oxygen (PO₂). The sensor has an inherent absolute zero, therefore, no oxygen no signal output.

Life: In theory, sensor life is limited by the amount of anode material and signal output. A higher signal output yields a shorter life because the anode is being consumed at a faster rate. In reality, however, the Expected Life specification considers the signal output range. In general, sensor life is inversely proportional to changes from the specified parameters: oxygen concentration (air 20.9%) and pressure (1 atm), and, exponentially (2.5% per °C) for temperature (25°C/77°F).

Signal Output: A higher or lower signal output within the specified output range offers no performance advantage. The PCB network converts the signal output from current (μA) to (mV) signal output. Signal output can be influenced (and compensated) by several factors such as oxygen concentration, temperature and pressure. However the design of sensors for low level measurements involves a delicate balance between a higher signal output that improves stability by reducing the influence of temperature, and, life.

Temperature: Influences the signal output at the rate of 2.54% per °C. Ambient (gradual) changes in temperature can be compensated within the $\pm 2\%$ accuracy specification by processing the signal output through an appropriate resistor-thermistor temperature compensation network. Step (rapid) changes should be avoided or allowed at least 15 minutes for the signal output and temperature compensation network to equalize. The effect depends on the temperature change inside the breathing circuit. Some rebreather manufacturers compensate electronically to eliminate the effect of temperature.

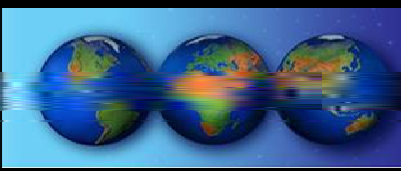

Pressure: Influences signal output on a proportional basis. Tests show sensors are accurate at any constant pressure up to 30 atm provided the sensor is pressurized equally front and rear. A pressurized sensor must decompress gradually (similar to a human).

Altitude: Dives of 200 ft. produce an error of 0.3% and do not have a significant effect on the signal output.

Humidity: Water vapor according to Dalton's Law of Partial Pressure exerts its own partial pressure when added to a gas stream, thereby, reducing the partial pressure of oxygen and the reading displayed. Conversion charts are available for air calibration which define the effect of humidity on the oxygen level.

Carbon Dioxide (CO₂): An acid gas that reacts with the sensor's base electrolyte. The effect on the sensor varies with exposure time. Exposure to CO₂ for 15-20 minutes followed by flushing with air has virtually no effect on the sensor. Repeated exposure of 3-4 hours can result in a temporary loss of signal output. Continuous exposure has a dramatic effect on sensor life. For example a sensor with a normal 12 month life in air at 77° and 1 atm that is continuously exposed to 5-6% CO₂ will expire in 3-4 weeks.

Load: The sensor does not tolerate reverse current flowing into the sensor. No load is recommended, but 10K Ohm is the maximum permissible. Exceeding a load of 10K Ohm produces an error in linearity.

Calibration: Follow the recommendations included in the rebreather manufacturer's Owner's Manual. Perform at or near operating conditions, e.g. if measuring dry compressed gas, calibrate with same or if calibrating in air use a conversion chart which defines the effect the humidity (above) and temperature on the oxygen level. Do not calibrate with air when intending to measure above 30% oxygen, calibrate with 100% oxygen.

Mode of Failure: Defect or Misuse

Preface: Historically, when a sensor does not function beyond its warranty period the issue of what is a defect as opposed to misuse arises. The intent here is to explore the effects and possible causes objectively.

Normal Operation: When operated at or near the specified parameters (see sections of Signal Output and Life) signal output and anode consumption remain constant over 80-90% of the sensor's expected life. As the signal output decreases it falls below the lower limit of the electronic design and eventually preventing calibration of the electronics.

Storage: Prolonged exposure above 50°C (122°F) can weaken the seals that secure the front and rear membranes to the sensor and accelerate sub-microscopic pin holes (that escape a stringent leak test that every sensor passes) in the laminated front sensing membrane both of which may result in electrolyte leakage in the shipping bag. Each degree above the specified parameter of 25°C (77°F) reduces expected sensor life by increasing the internal rate of reaction which accelerates the consumption of the anode.

Shock: Can compromise electrical connections, break wires or cause a tear in the sensing membrane resulting in erratic readings. Dropping a sensor from 3 ft. onto a carpeted concrete office slab (a) reduced signal output by at least 25% or worse (b) dislodged the anode contacted a cathode wire thus creating a short circuit.

Erratic Oxygen Readings: Can result from a) shock; b) an aged sensor or well used sensor that is 2-3 years from its manufacture date (see Serialization/Date Code); c) blocking the "breather holes" in the PCB at the rear of the sensor prevents the pressure surrounding the sensor (front and rear) from equalizing; d) a load in excess of 10K Ohm; e) repeated exposure to CO₂ of 3-4 hours can result in a temporary loss of signal output, see Carbon Dioxide CO₂.

Higher than Expected Oxygen Readings: Result when minute pinholes (see Storage) or tears in the sensing membrane allow additional unwanted oxygen to enter the sensor. The most common causes are the shock of dropping a sensor or pressing on the sensing surface in an attempt to remove liquid. Exposure to CO₂ can also cause a temporary increase in the oxygen reading.

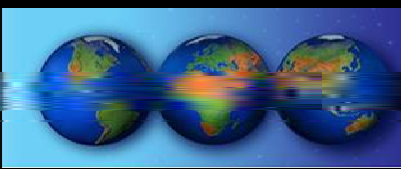

Liquid/Moisture: Condensation on the sensing surface of the sensor reduces the signal output by blocking the diffusion of oxygen into the sensor and is mistakenly categorized as a sensor defect. The reality, there is no damage to the sensor, simply remove the liquid and the signal output returns.

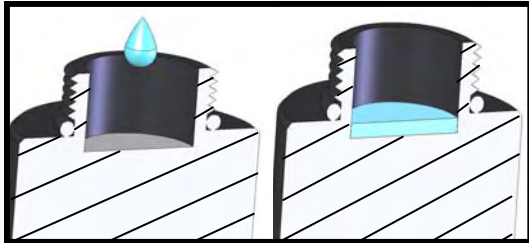

Complete Coverage: Signal output decreases 12mV to 10mV (17%) after 20 minutes.

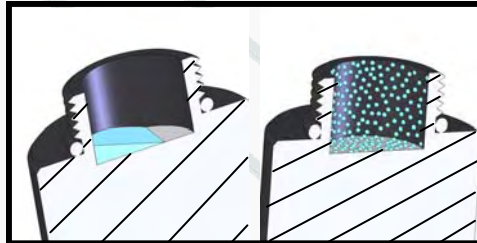

Partial Coverage: Signal output, no change.

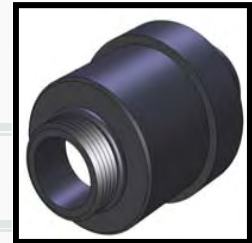

Orientation is important

Quality Control of Manufacturing

Design: After years of experience working with and studying competitive galvanic oxygen sensors, Analytical Industries has focused on advancing the quality and reliability along with performance of their sensors by simplifying the assembly process and eliminating sources of internal contamination. As a result, there are no welds, epoxy or dissimilar metals inside the Analytical Industries sensor.

Leak Test: A stringent proprietary test that detects microscopic pin holes in the laminated membranes and marginal membrane seals. 100% of the base electrolyte sensors are subjected to this stringent procedure and must pass successfully, otherwise they are scrapped.

Output Testing: Following leak test, all sensors sit for a predetermined period of time to allow the signal output to stabilize. Next, the current output (μA) of every sensor is tested and recorded.

Diving sensors are then equipped with a PCB that includes the appropriate electrical connector and the temperature compensation network which converts the current (μA) signal output to (mV) output. Each sensor is tested 3x more times during the remainder of the assembly process before the sensor is accepted and serialized.

Dive Pressure Test: Analytical Industries tests all diving sensors for output in air (20.9%) and linearity at 100% oxygen, and, under 1.6 ATA using a proprietary automated system developed in collaboration with rebreather manufacturers and instructors. As illustrated, individual test reports are generated for and a copy shipped with every sensor. The print out documents the following:

- chamber pressure (ATA),
- fractional oxygen in the mix (FO2),
- partial pressure O2 dosage (PO2),
- the sensor's signal output (mV) as the preceding parameters change,
- and, whether that output (Result) was within $\pm 3\%$ (PASS) of the calculated theoretical value demonstrating the linearity of the sensor or not (FAIL).

Model:	PSR-11-39-MD			
Serial No.:	01134361			
Date:	11/17/10			12:19
ATA	FO2	PO2	mV	Result
0.954	0.215	0.205	14.02	PASS
0.954	0.990	0.944	65.59	PASS
1.546	0.990	1.530	105.04	PASS

Dalton's Law: $\text{ATA} \times \text{FO2} = \text{PO2}$

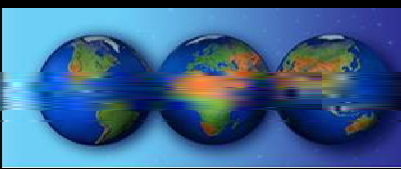

Quality Assurance Program

Quality is taken very seriously. Mandated for medical devices, industrial and diving products comply with the same quality standards. The quality assurance program is independently certified annually by and conforms to:

- ❑ ISO 9001:2008,
- ❑ U.S. FDA: 510(k) No. K952736,
- ❑ Europe: Annex II of Medical Device Directive 93/42/EEC as amended by 2007/43/EEC,
- ❑ Canada: ISO 13485:2003



Our approach to customer service is proactive one, every product returned from the field requires a formal written assessment report a copy of which is sent to the customer. We routinely contact customers to discuss and educate, and in many cases ourselves as well.

Historically, less than 1% of the sensors shipped are returned to Analytical Industries Inc. for warranty claims, and, of that figure less than one-half are determined to have manufacturing defects. Assessing these returns along with internal manufacturing yields has enabled Analytical Industries Inc. to continually improve our products and secure additional business.

Serialization / Date Code

Oxygen sensors have a finite life. Understanding the date code embodied in the serial number is critical to determining the age or manufacture date of a sensor, maximizing the benefit of the warranty period. The serial number 90734789 breaks down as follows:

Digit #1:	9 identifies the year of manufacture as 2009
Digits #2,3:	07 identifies the month of manufacture as July
Remaining:	Sequentially issued for uniqueness

To avoid diving with aged sensors, labeling of all rebreather sensors includes a SELL BY date (4 months) and DO NOT USE AFTER date (16 months) from the month and year of manufacture specified or July 2009 in the above example.

Warranty Policy

Coverage: Under normal operating conditions, the sensors are warranted to be free of defects in materials and workmanship for the period specified in the current published specifications.

Analytical Industries in their sole discretion shall determine the nature of the defect. If the item is determined to be eligible for warranty we will repair it or, at our option, replace it at no charge to you. This is the only warranty we will give and it sets forth all our responsibilities, there are no other express or implied warranties. The warranty period begins with the date of shipment from Analytical Industries Inc. This warranty is limited to the first customer who submits a claim for a given serial number. Under no circumstances will the warranty extend to more than one customer or beyond the warranty period.

For info call 909-392-6900, fax 909-392-3665 or e-mail diveaii@aii1.com. To make a warranty claim, you must return the item and postage prepaid to: Analytical Industries Inc., 2855 Metropolitan Place, Pomona, Ca 91767 USA

Exclusions: This warranty does not cover normal wear and tear; corrosion; damage while in transit; damage resulting from misuse or abuse; lack of proper maintenance; unauthorized repair or modification of the analyzer; fire; flood; explosion or other failure to follow the Owner's Manual.

Limitations: Analytical Industries Inc. shall not liable for losses or damages of any kind; loss of use of the analyzer; incidental or consequential losses or damages; damages resulting from alterations, misuse, abuse, lack of proper maintenance; unauthorized repair or modification of the analyzer.

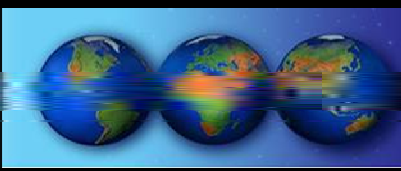

What We Have Learned . . .

The effects of the topics listed below are discussed in detail in the preceding pages and in the interest of brevity are not duplicated.

Challenging Application: When it comes to the closed circuit rebreather the oxygen sensor is exposed to an environment that plays to more of the device's weaknesses than its strengths. That is not to say the oxygen sensor is not suited for this application, but getting the most out of the oxygen sensor requires working around the limitations, understanding the device and a little discipline in terms of handling and maintenance.

Preventive Maintenance: Our investigation has yielded a surprising number of cases involving diving with old sensors, the lack of regular sensor replacement and failure to follow the rebreather manufacturer's calibration procedure.

Design: Currently there are no regulations governing rebreather manufacturers which accounts for the various designs on the market.

Temperature: The CO₂ scrubber generates heat which keeps the temperature inside the rig around 90°F. The design should locate the oxygen sensor in the coolest location possible.

Liquid: The heat generated by the CO₂ scrubber also produces a continual source of condensation which does not damage the sensor itself. Again the design should position the oxygen sensors to minimize or prevent the collection of water on the sensing surface.

Electronics: The quality of the computer systems used to control today's rebreathers vary from rig to rig. If the electronics are flooded or malfunction a charge can be sent to the oxygen sensor resulting in permanent damage to the sensor, see Load. Electrical connectors should gold and kept watertight. However, using rubber-type caps to seal the connections at the back of the sensor can cause an unwanted pressure differential between the front and back of the sensor.

Recommended Maintenance: Rebreather Owner's Manuals repeatedly warn users to follow recommended maintenance procedures for post dive of opening and flushing the rig, proper inspection and lubrication of o-rings and seals to prevent leaks which could expose the oxygen sensors to oxygen levels of 70-100% and exposure to CO₂.

Shock: Even contributors to the internet forums admit the rigs (and the components inside) are not accorded the proper handling, an issue for electronics as well as the oxygen sensor.